

Site Walk Report

Training Project - Innovation Depot

1500 1st Avenue North
Birmingham, AL 35203



Condoit Training Account

Created: Jul 31 2024

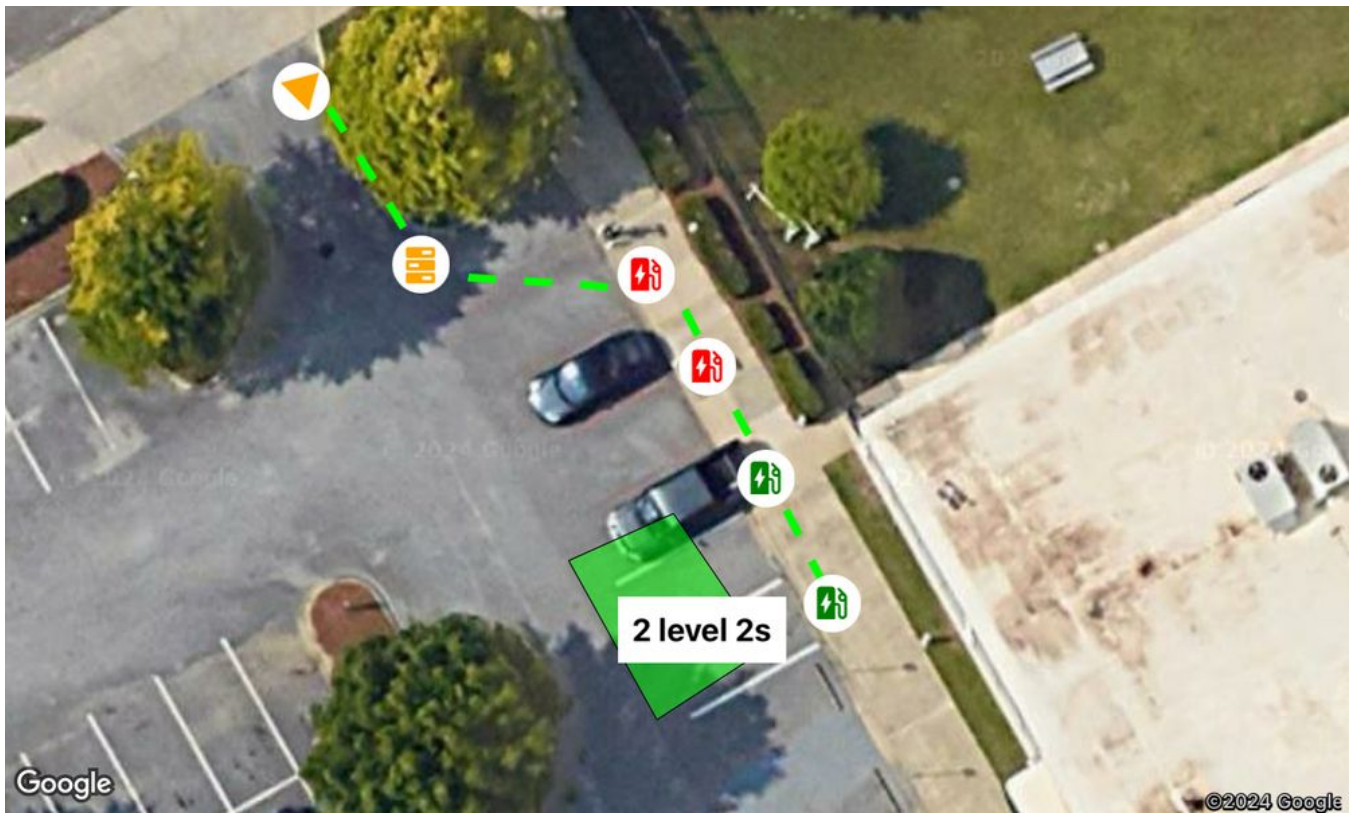

Site Plan



-  New Utility Transformer
-  Existing Utility Transformer
-  Electrical Room



-  New EV Charger
-  New Switchgear
-  Existing EV Charger



Project Information

Project Overview

Directions for Technician:

Customer needs a quote to add 2 level 2 chargers. Install should be adjacent to the existing 2 chargers in the main parking lot. Take photos and videos of the area for new switchgear. Be sure to get a key from Glenda at the front desk

Site Walk Information

Date Site Walk Completed: Aug 02 2023

Individual Performing Site Walk: Anne Randall

Email: Anne@conduit.io

Customer Information

Name/Company: Innovation Depot

Primary Contact Person: Emily Frontdesk

Email: frontdesk@depot.com

Phone: (659) 999-9999

Site Information

Site Use: Commercial - Retail

Parking Type: Surface Lot

Distance From Electrical Room to Charger Site (feet): 100

Charger Use

Will chargers be available to the public?: Yes

Are there existing chargers on site?: Yes



As-Built Electrical Plans

Are there existing electrical plans? Verify with owner: Yes

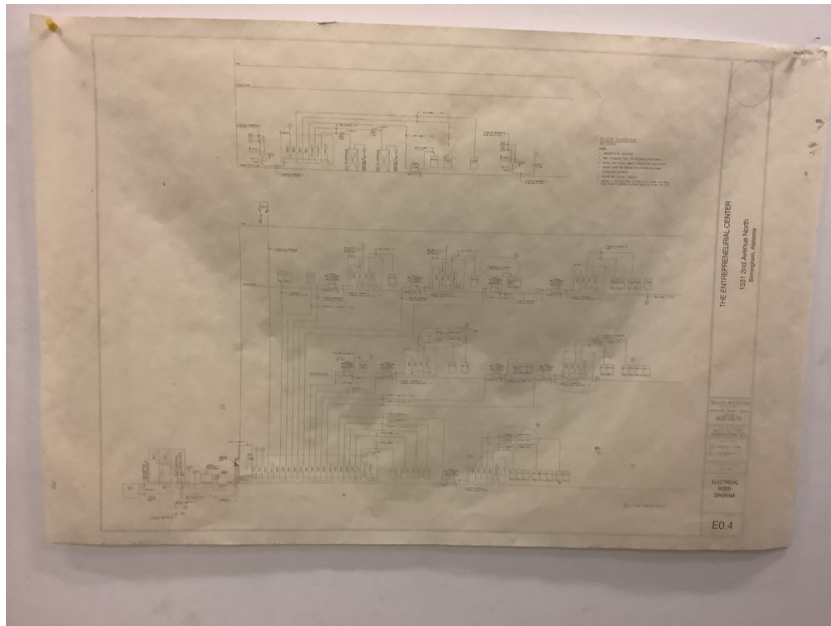

Existing Site Plans

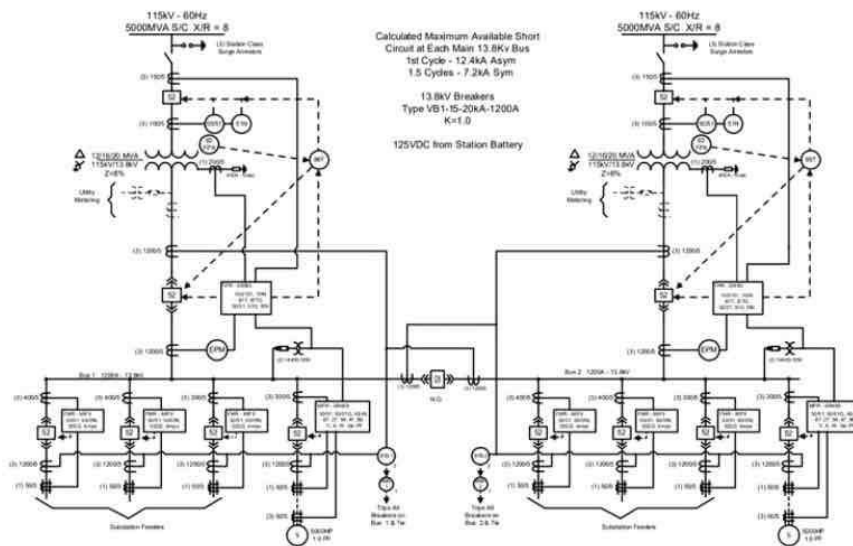



Site Narrative

General Notes:

New utility connection and switchgear should be installed on the north side of building on 2nd Ave North. 2 existing chargers.



Site Photos & Videos

Electrical Room

Notes: Electrical room includes two switchboards three panels and a busduct





[View video in Conduit project](#)





New Utility Transformer







New Switchgear Location





Proposed Charger Location





Conduit Run to Charger



View video in Conduit project [↗](#)

Conduit Run to Receptacle

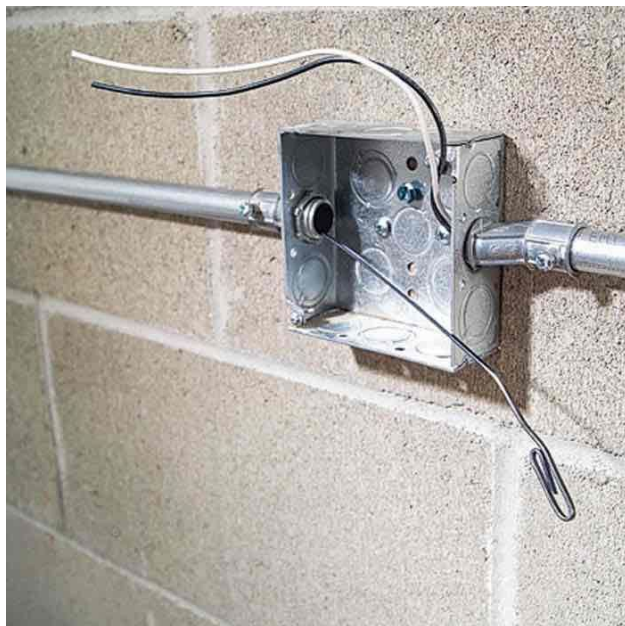





Equipment

Generator - Gen 1

KVA Rating: 50

Location: Loading doc

Phase/Wire: 3phase-4wire

Voltage: 480V Delta

Other



Generator - Main Gen

KVA Rating: 100

Phase/Wire: 1phase-3wire

Voltage: 277/480V

Utility Transformer - Alabama Power

kVA Rating: 1000

Site Walk Report



Location: 2nd Ave North loading dock

Phase/Wire: 3phase-4wire

Service Provider: Alabama Power

Utility ID: 88-51693

Voltage: 277/480V Y

Other



Site Walk Report







Switchboard - Main Breaker

Location: Loading dock

Measured load: A-Phase: 0

Measured load: B-Phase: 0

Measured load: C-Phase: 0

Phase/Wire: 3phase-4wire

Voltage: 277/480V Y



Other





Panel - Panel A

Meter attached?: false

Left Breaker Spaces: 0

Location: Electric room

Main type (MLO, MBO, etc): Main Breaker

Measured load: A-Phase: 10

Measured load: B-Phase: 10

Measured load: C-Phase: 10

Phase/Wire: 3phase-4wire

Right Breaker Spaces: 0

Site Walk Report



Voltage: 277/480V Y

Switchboard - Main Switchboard

Location: Electrical Room

Measured load: A-Phase: 0

Measured load: B-Phase: 0

Measured load: C-Phase: 0

Phase/Wire: 3phase-4wire

Voltage: 277/480V Y

Other

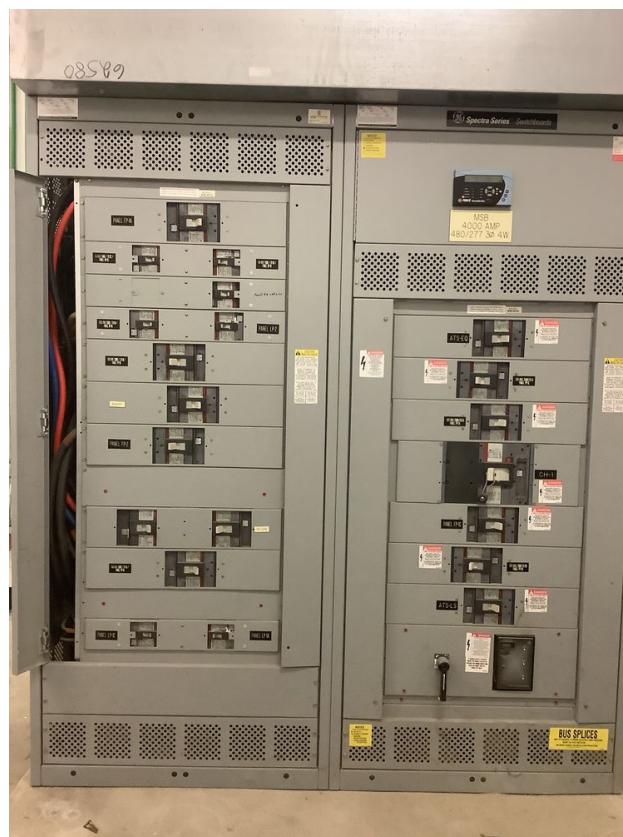



Automatic Transfer Switch - ATS LS

Location Description: Electrical Room 2

Phase/Wire: 3phase-4wire

Site Walk Report



Voltage: 480V Delta

Switchboard - FP EM LS - Floor 1

Location: Electrical Room - Floor 1

Measured load: A-Phase: 10

Measured load: B-Phase: 10

Measured load: C-Phase: 10

Phase/Wire: 3phase-4wire

Voltage: 277/480V Y

Other



Switchboard - FP EM LS - Floor 2



Location: Electrical Room - Floor 1

Measured load: A-Phase: 10

Measured load: B-Phase: 10

Measured load: C-Phase: 10

Phase/Wire: 3phase-4wire

Voltage: 480V Delta

Transformer - TX 1D

Kva Rating: 50

Location Description: Electrical room

Primary Phase/Wire: 3phase-4wire

Primary Voltage: 480V Delta

Secondary Phase/Wire: 3phase-4wire

Secondary Voltage: 120/208V Y



Other





EV Charger - Charger

Amperage Rating: 10

Level: 2

Location: Main Parking Lot

Manufacturer: EnviroSpark

Number of Ports: 2

EV Charger - Charger Photos

Amperage Rating: 10

Level: 2

Location: Main Parking Lot



EV Charger - Charger

Amperage Rating: 40

Level: 2

Manufacturer: EnviroSpark

Number of Ports: 2



Other

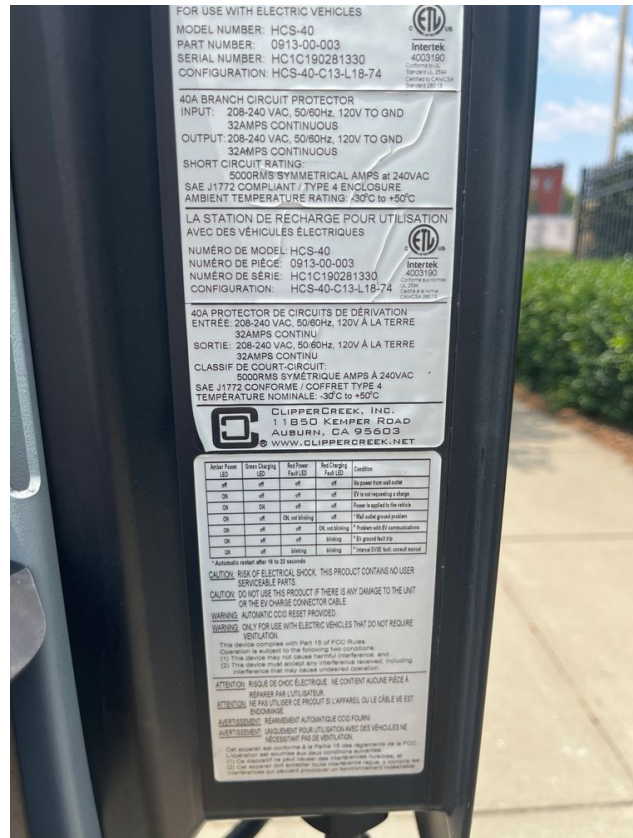



Generic Load - Hot Tub

Amperage Rating: 40

Phase/Wire: 3phase-4wire

Voltage: 480V Delta

EV Charger - New Charger

Amperage Rating: 10

Level: 2

Manufacturer: BTCPower

Number of Ports: 2

Panel - Pp1



Meter attached?: false

Left Breaker Spaces: 0

Location: Electricl room

Main type (MLO, MBO, etc): Main Breaker

Phase/Wire: 1phase-3wire

Right Breaker Spaces: 0

Voltage: 277/480V

Motor - ABK6-FLP

Amperage Rating: 20

Location: Loading Dock

Panel - Rp1d

Meter attached?: false

Left Breaker Spaces: 0

Location: Electrical room

Main type (MLO, MBO, etc): Main Breaker

Measured load: A-Phase: 0

Measured load: B-Phase: 0

Measured load: C-Phase: 0

Phase/Wire: 3phase-4wire

Right Breaker Spaces: 0

Voltage: 120/208V Y



Front (Closed)





Front (Open)





Panel Schedule

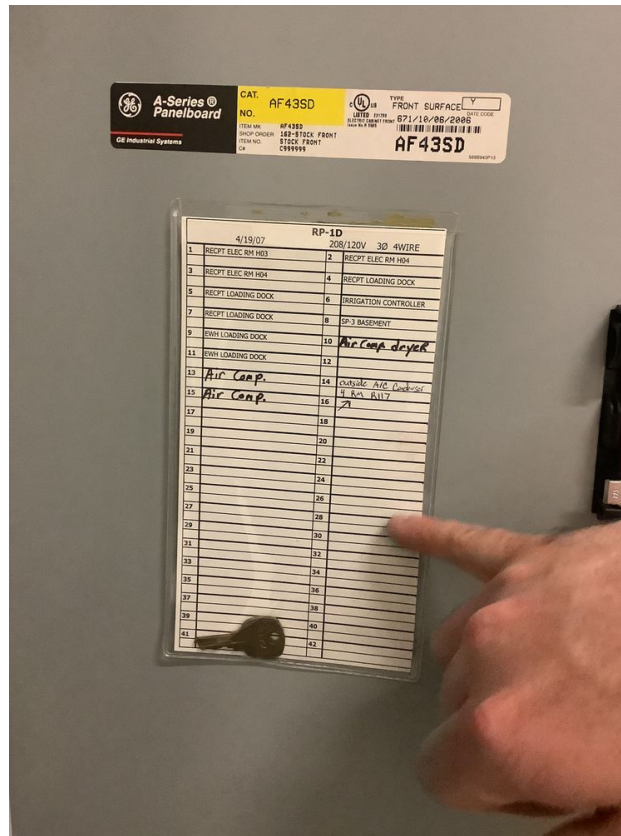

Generic Load - Outside AC Condenssor

Amperage Rating: 30

Phase/Wire: 3phase-4wire

Voltage: 120/208V Y